

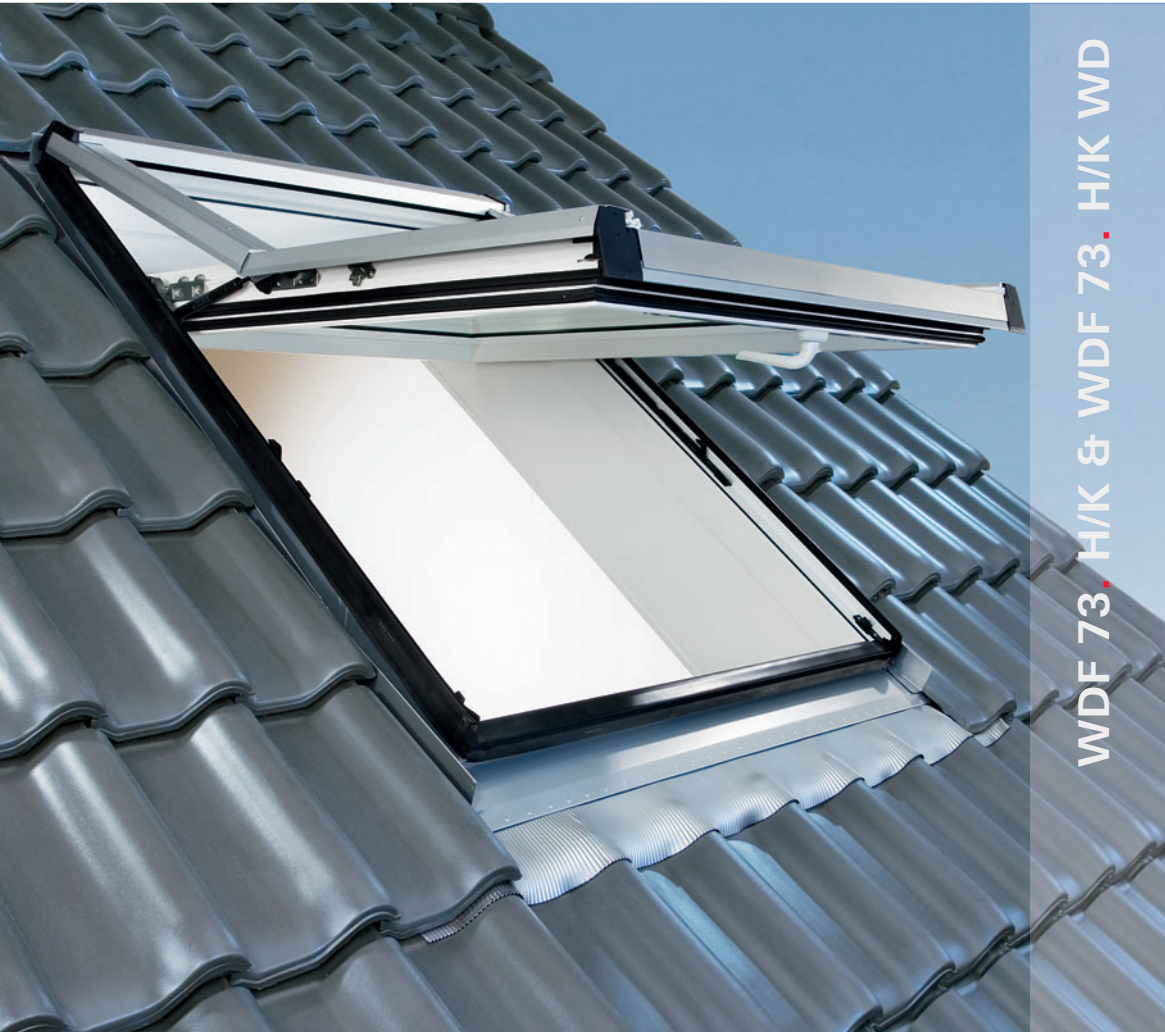

Wohndachfenster 7

Roof window 7



WDF 73. H/K & WDF 73. H/K WD



Deutschland

Hinweise/Sicherheitshinweise

- Die allgemeinen Unfallverhütungsvorschriften bei Dacharbeiten beachten.
- Die Baustelle gegen herabfallende Teile sichern.
- Bauphysikalische Grundlagen wie Wärmedämmung, Feuchteschutz, Regensicherheit/Wasserdichtheit und Lärmschutz beachten.
- Die Zahlen geben immer die Reihenfolge der Montage an!
- Technische Änderungen vorbehalten.

 Eingriffe in Tragwerkkonstruktionen dürfen nur von qualifizierten Fachkräften ausgeführt werden!

Für Einbaulatten nur Holz der Sortierklasse S. 13 verwenden. Die Höhen der Dachlatten und die Höhe der Einbaulatten müssen gleich sein!

Nederland/Belgique **Veiligheid/aandachtspunten**

- U dient bij werkzaamheden aan/op het dak de algemene voorschriften ter voorkoming van ongevallen in acht te nemen.
- U dient de bouwplaats tegen neervallende delen te beveiligen.
- U dient de bouwkundige principes zoals warmte-isolatie, vochtwering, bescherming tegen regenwater/ waterdichtheid en geluidswering in acht te nemen.
- De getallen geven altijd de volgorde van de montagewerkzaamheden aan!
- Technische veranderingen voorbehouden.

 Ingrepen in de draagconstructies mogen uitsluitend door daartoe gekwalificeerd personeel worden uitgevoerd!

Voor inbouwlaten mag u alleen hout van sorteerklassen S13 gebruiken. De hoogte van de daklatten en de hoogte van de inbouwlaten moeten gelijk zijn!

France

Conseil/ Recommandation de sécurité

- Respecter le règlement général de prévention des accidents pour les travaux sur le toit.
- Assurer le chantier contre la chute de matériaux.
- Respecter les conditions de base relatives à la physique de bâtiment telles que l'isolation thermique, la protection contre l'humidité, contre la pluie/étanchéité à l'eau et protection contre le bruit.
- Les chiffres indiquent toujours l'ordre du montage !
- Sous réserve de modifications.

 Les interventions au niveau éléments porteurs ne doivent être réalisées que par une main-d'œuvre qualifiée!

Pour les lattes d'installation, utiliser exclusivement du bois sans nœuds et sans fissures. L'épaisseur des liteaux et l'épaisseur des lattes d'installation doivent être identiques!

España

Consejo/recomendación de seguridad

- Tenga en cuenta las prescripciones generales de prevención de accidentes para trabajos en el tejado.
- Asegure la obra contra objetos que pudieran caer.
- Tenga en cuenta los principios físicos constructivos tales como aislamiento térmico, protección contra la humedad, seguridad contra el agua y protección contra el ruido.
- Los números indican siempre el orden de montaje.
- A reserva de modificaciones.

 Cualquier modificación en los elementos estructurales debe ser realizada únicamente por personal especializado!

Utilizar únicamente madera de la clase de selección MS 13 para los listones que se desean. La altura de los listones del tejado y de los listones que se desean montar debe ser igual!

Great Britain

Safety advice/recommendations

- Observe the general regulations for prevention of accidents concerning work on the roof.
- Secure site against falling parts.
- Observe basics of building physics, as heat insulation, protection against moisture, rain shielding/waterproofness, and noise protection.
- The numbers specify the assembly sequence.
- We reserve the right to make any amendment.

 Work on the frame structure may only be performed by qualified personnel!

For installation laths, use wood of the grading class MS 13/C35 only. The thickness of the roof battens and the thickness of the installation laths have to be identical!

Portugal

Conselhos/recomendações de segurança

- Cumpra com as normas gerais para a prevenção de acidentes.
- Proteja o local da construção contra a queda de quaisquer peças.
- Atenda aos princípios fundamentais fisicotécnicos da construção civil, tais como isolamento térmico, protecção anti-humidade, segurança pluvial/impermeabilidade à água e protecção contra a poluição sonora.
- Os algarismos indicam sempre a ordem da montagem!
- Sob reserva de modificações.

 A realização de toda e qualquer intervenção nos vigamentos só está autorizada a pessoal especializado devidamente qualificado!

Utilize exclusivamente madeira da classe de qualidade S 13 para as fasquias de montagem. Tanto as alturas das ripas do telhado como a altura das fasquias de montagem deverão ser idênticas!

Polska

Wskazówki/wskazówki bezpieczeństwa

- Należy przestrzegać ogólnych przepisów bezpieczeństwa pracy przy robotach dachowych.
- Zabezpieczyć miejsce budowy przed spadającymi częściami.
- Przestrzegać przy montażu podstaw fizyki budowlanej takich jak: izolacja cieplna, ochrona przeciwwilgociowa, zabezpieczenie przed deszczem/wodoszczelność i dźwiękoszczelność.
- Cyfry podają kolejność montażu!
- Zmiany techniczne zastrzeżone.

 Wszelkich ingerencji w konstrukcje nośne mogą dokonywać wyłącznie wykwalifikowani fachowcy!

Do montażu stosować wyłącznie łąty z drewna o jakości klasy I. Grubość łąt dachowych i łąt montażowych musi być identyczna!

Latvija

Norādījumi/drošības norādījumi

- Jāievēro vispārējie drošības darba pasākumi pie jumta darbiem.
- Nodrošināt, lai celtniecības vietu neapdraud kritošas konstrukcijas vai priekšmeti.
- Veicot montāžu jāievēro fizikas pamatlikumi, tādi kā: termoizolācija, aizsardzība pret mitrumu, nodrošinājums pret lietu un skaņas izolācija.
- Cipari norāda montāžas secību.
- Pieļaujamas tehniskas izmaiņas.

 Jebkādas uzlabojumus nesošajās konstrukcijās var veikt tikai kvalificēti darbnieki!

Montāžai lietot tikai pirmšķirīgas kvalitātes koka łątas. łątām jumta latojumā jābūt vienādā biezumā!

Россия/ Україна

Указания/рекомендации по безопасности

- Ознакомьтесь с общими указаниями во избежание травматизма при работе на крыше:
- Обезопасьте строительную площадку на случай падения используемого материала / инструмента.
- При монтаже соблюдайте основные принципы из области строительной физики, такие как тепло-, паро-, гидро- и звукоизоляция.
- Цифры на рисунках показывают последовательность их монтажа!
- Производитель оставляет за собой право на внесение изменений.

 Работы с несущими конструкциями здания и любые изменения в них могут производиться только квалифицированным персоналом!

Для монтажных реек должна использоваться древесина первого сорта. Высота обрешетки реек должна быть одинаковой!

Lietuva

Nurodymas/saugumo taisyklės

- Būtina imtis bendrų darbo saugumo priemonių.
- Apsaugoti darbo vietą nuo krentančių elementų.
- Laikytis statybinių normų reikalavimų šilumos izoliacijai, drėgmės izoliacijai, nepralaidumui lietaus vandeniui, garso izoliacijai.
- Skaičiai paveikslėliuose parodo montavimo eiliškumą.
- Galimi techniniai pakitimai.

 Bet kokius pakeitimus lango konstrukcijoje gali atlikti tik kvalifikuotas personalas!

Jeigu, montuojant stogo łątus, neužtenka atstumo tarp gegnių, stogo konstrukcijos perdarymas galimas tik iš tokios pat medienos kaip ir gegnės!

Eesti

Näpunäited/ohutusjuhend

- Katusel töötades tuleb pidada kinni üldistest ohutustehnika eeskirjadest.
- Kaitsta töökoht ülevalt langevate esemete eest.
- Paigalduse käigus pidada kinni ehitusfüüsika põhialustest: soojusisolatsioon, kaitse niiskuse eest, kaitse vihma eest/veekindlus ja heliisolatsioon.
- Numbrid juhise piltidel näitavad paigaldusetappide järjekorda!
- Tootja jätab endale õiguse tehniliste muudatuste sisseviiamiseks.

 Kandekonstruksioonide võivad muuta ainult vastavat kvalifikatsiooni omavad töötajad!

Akna paigalduslattidena kasutada ainult I klassi puitu. Roovlattide ja akna paigalduslattide paksus peab olema võrdne!

Česká republika

Doporučení/bezpečnostní upozornění

- Dodržujte všeobecné bezpečnostní předpisy pro práci na střeše.
- Zajistěte staveniště proti případnému pádu dílů.
- Respektujte stavebně-fyzikální podklady týkající se tepelné izolace, ochrany proti vlhkosti, vodotěsnosti při dešti a sněžení a ochraně proti hluku.
- Čísla vždy vyjadřují posloupnost jednotlivých kroků montáže!
- Technické změny vyhrazeny.

 Zásahy do nosné konstrukce střechy mohou provádět jen kvalifikovaní pracovníci!

Pomocné montážní łątě musejí být ze dřeva bez suků a prasklin. Výška střešních łąt a pomocných montážních łąt musí být stejná!

Slovenská republika Pokyny/bezpečnostné upozornenie

- Dodržiavajte všeobecné bezpečnostné predpisy pre prácu na streche.
- Zabezpečte stavenisko proti prípadnému pádu dielcov.
- Rešpektujte stavebno-fyzikálne podklady týkajúce sa tepelnej izolácie, ochrany proti vlhkosti, vodotesnosti pri daždi a snežení a ochrany proti hluku.
- Čísla vždy vyjadrujú postupnosť jednotlivých krokov montáže!
- Technické zmeny vyhradené.

 Zásahy do nosnej konštrukcie strechy môžu vykonávať len kvalifikovaní pracovníci!

Pomocné montážne laty musia byť z dreva bez uzlov a prasklín. Výška strešných lát a pomocných montážnych lát musí byť rovnaká!

Italia Consigli/Indicazioni di sicurezza

- Durante i lavori sul tetto osservare le norme antinfortunistiche generali.
- Assicurare il luogo di lavoro contro la possibile caduta dei pezzi.
- Osservare i principi fondamentali fisici di costruzione quali l'isolamento termico, l'isolamento per l'umidità, la protezione contro l'acqua piovana/impermeabilità all'acqua, la protezione acustica.
- I numeri indicano sempre la sequenza di montaggio!
- Escluse modifiche tecniche.

 Gli interventi nelle strutture portanti devono essere eseguiti solo dal personale specializzato!

Per le assicelle di montaggio utilizzare solo legno senza nodi ed incrinature. Le altezze dei listoni del tetto e le altezze delle assicelle di montaggio devono essere uguali!

Magyar Köztársaság Utasítások/Biztonsági előírások

- A tetőfedő munkáknál figyelembe kell venni a balesetvédelmi előírásokat.
- Biztonság a beépítés helyszínén, hogy az esetlegesen lehulló hulladék, illetve egyéb anyagok ne okozzanak balesetet.
- Vegyék figyelembe az épületfizikai alapokat, így a hőszigetelést, nedvességvédelmet, vízzáróságot és zajvédelmet.
- A számok mindig a szerelés sorrendjét mutatják.
- Műszaki változtatások jogát fenntartjuk.

 A tartószerkezetekhez csak képzett szakemberek nyúlhatnak hozzá!

A lécezéshez csak csomó és repedésmentes fát szabad felhasználni. A tetőlécek és a segédlécek magassága megegyező legyen!

Hrvatska/Bosna i Hercegovina Napomene/sigurnosne napomene

- Pridržavajte se općih propisa sigurnosti za radove na krovu.
- Osigurajte gradilište od dijelova koji mogu pasti s krova.
- Pridržavajte se građevinsko fizikalnih osnova kao što su toplinska izolacija, zaštita od vlage, sigurnost od prodora kiše/brtvljenje i zaštita od buke.
- Brojevi označavaju redoslijed kod montaže!
- Pridržano pravo tehničkih izmjena.

 Radove na nosivim konstrukcijama smiju izvoditi samo kvalificirani stručnjaci!

Za ugradbene letve upotrebljavajte samo drvo 1. klase. Visina krovnih letava i visina ugradbenih letava mora biti jednaka!

Slovenija Navodila

- Upoštevajte splošne predpise za varnost na strehi.
- Zavarujte gradbišče pred padajočimi deli s strehe.
- Upoštevajte gradbeno fizikalne osnove, kot so toplotna izolacija, zaščita pred vlago, varnost pred vdorom dežja/vode in zaščita pred hrupom.
- Številke vedno kažejo vrstni red vgradnje!
- Pridržujemo si pravico do tehničnih sprememb.

 Posege na nosilni konstrukciji smejo izvajati le kvalificirani strokovnjaki!

Za vgradne letve uporabljajte le les vrste S 13. Višina strešnih letev in vgradnih letev mora biti enaka!

Greece Συμβουλή/σύσταση ασφαλείας

- Τηρήστε τα γενικά προληπτικά μέτρα ασφαλείας για τις εργασίες σε οροφές κτιρίων.
- Ασφαλίστε το εργοτάξιο από τυχόν πτώση αντικειμένων.
- Λάβετε υπόψη τις βασικές φυσικές κατασκευαστικές αρχές, όπως η θερμομόνωση, η προστασία από την υγρασία, η προστασία από τη βροχή/η υδατοστεγανότητα και η αντιθρομβική προστασία.
- Οι αριθμοί αντιστοιχούν πάντα στη σωστή σειρά τοποθέτησης!
- Με την επιφύλαξη τροποποιήσεων.

 Οι επεμβάσεις στη φέρουσα κατασκευή επιτρέπεται να πραγματοποιούνται αποκλειστικά από εξειδικευμένο προσωπικό!

Για τις δοκούς τοποθέτησης χρησιμοποιήστε αποκλειστικά ξύλο της κατηγορίας ταξινόμησης S 13. Το ύψος των δοκών της οροφής και το ύψος των δοκών τοποθέτησης πρέπει να είναι το ίδιο!

Romania

Măsuri de siguranță

- Respectați măsurile de siguranță valabile pentru lucrările pe acoperiș.
- Asigurați șantierul contra căderii oricăror obiecte de pe acoperiș.
- Respectați regulile impuse de fizica acoperișului cum ar fi : termoizolația, hidroizolația, protecția contra precipitațiilor, protecția contra umezelii și protecția fonică.
- Numerele reprezintă întotdeauna ordinea!
- Ne rezervăm dreptul a face schimbări din punct de vedere tehnic.

- ⚠ Lucrările legate de structura de bază/siguranță efectuate la acoperiș se execută numai de către personalul calificat.

Pentru stinghiile de fixare a se folosi numai lemn calitatea I .
Înălțimea stinghiilor și al caroiajului trebuie să fie egală.



ZIN

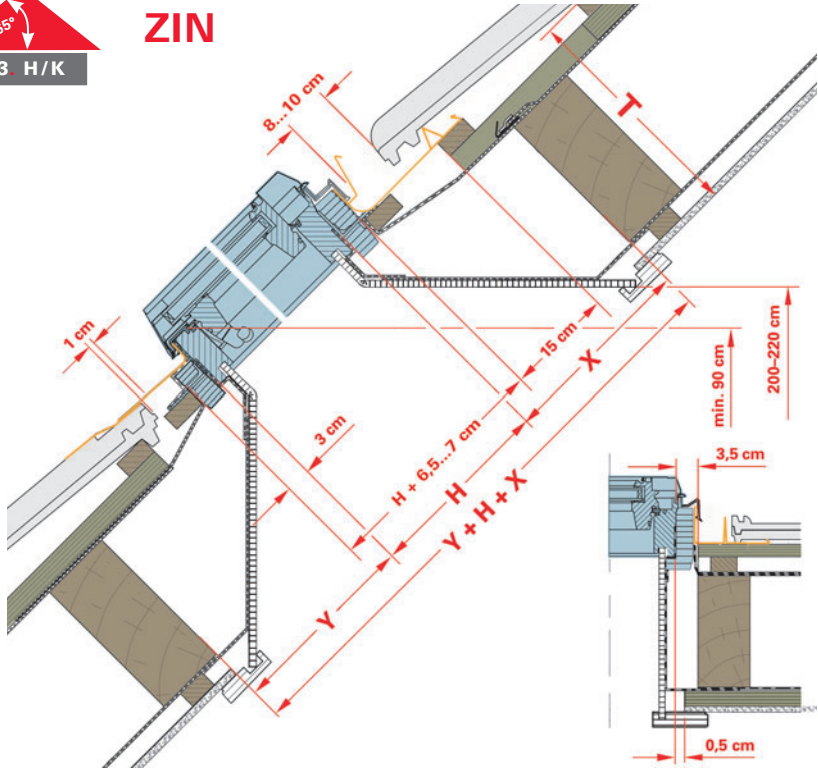

ZIN ▲		20°	25°	30°	35°	40°	45°	50°	55°	60°	65°	70°
T=26 cm	X	48	38	31	25	21	18	15	13	11	9	7
	Y	7	9	11	13	15	18	21	25	31	38	48
T=28 cm	X	54	42	34	28	24	20	17	14	12	10	8
	Y	8	10	12	14	17	20	24	28	34	42	54
T=30 cm	X	59	46	38	31	26	22	18	15	13	10	8
	Y	8	10	13	15	18	22	26	31	38	46	59
T=32 cm	X	65	51	41	34	28	24	20	17	14	11	8
	Y	9	11	14	17	20	24	28	34	41	51	65
T=36 cm	X	76	59	48	40	33	28	23	20	16	13	10
	Y	10	13	16	20	23	28	33	40	48	59	76
T=40 cm	X	87	68	55	45	38	32	27	22	19	15	12
	Y	12	15	19	22	27	32	38	45	55	68	87



ZIX

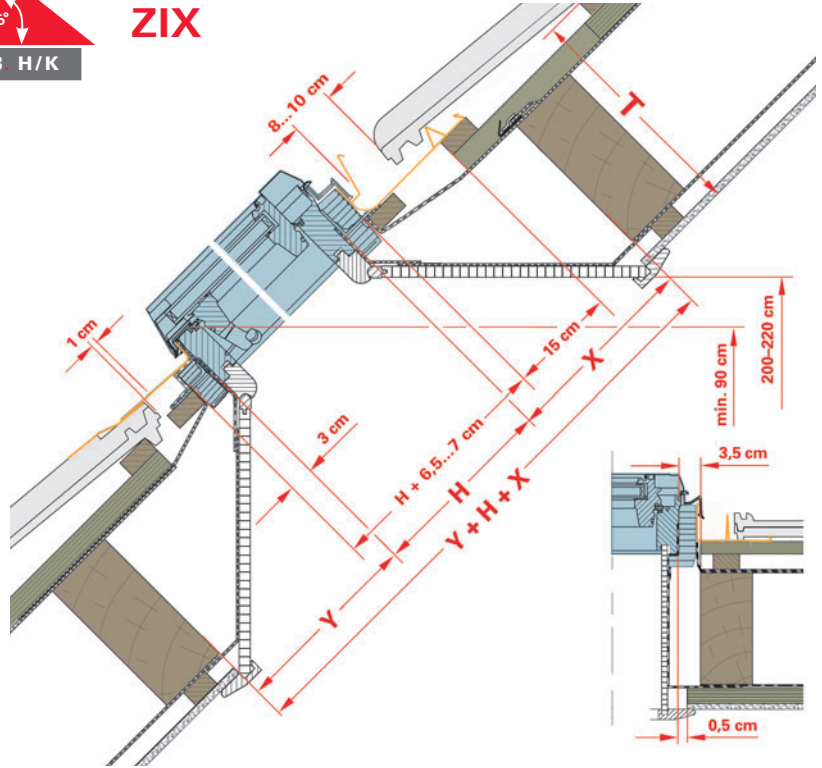

ZIX ▲		20°	25°	30°	35°	40°	45°	50°	60°	65°
T=26 cm	X	58	46	37	31	26	22	19	14	11
	Y	9	11	14	16	19	22	26	37	46
T = 28 cm	X	63	50	41	34	28	24	21	15	12
	Y	10	12	15	17	21	24	28	41	50
T = 30 cm	X	69	54	44	36	31	26	22	16	13
	Y	11	13	16	19	22	26	31	44	54
T = 32 cm	X	75	58	47	39	33	28	24	17	14
	Y	12	14	17	21	24	28	34	48	60

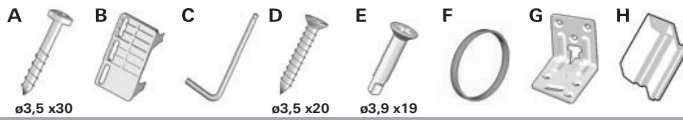
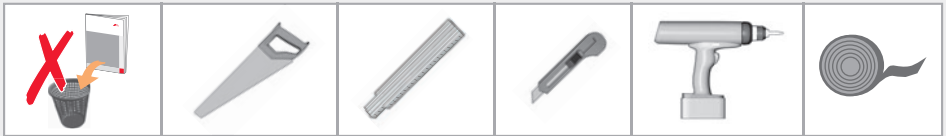

	A ø3,5 x30	B	C	D ø3,5 x20	E ø3,9 x19	F	G	H
73. K	8	1	1	2		2		8
73. K 13/09 13/14	12 16	3 5	1	2	/ 4	2	/ 2	8
73. K xx/11 xx/14	12	3	1	2	4	2	2	8
73. K xx/16	16	5	1	2	8	2	4	8
73. K WD	8	1	1	2		2		8
73. K WD 13/09 13/14	12 16	3 5	1	2		2		8
73. K WD xx/11 xx/14	12	3	1	2		2		8
73. K WD xx/16	16	5	1	2		2		8

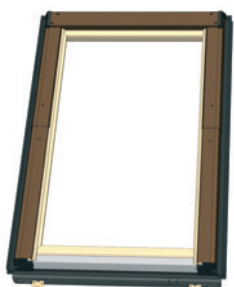

	A ø3,5 x30	B	C	D ø3,5 x20	F	I
73. H	8	1	1	2	2	
73. H xx/16	16	1	1	2	2	2
73. H WD	8	1	1	2	2	
73. H WD xx/16	12	1	1	2	2	

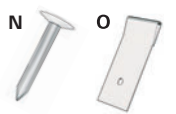
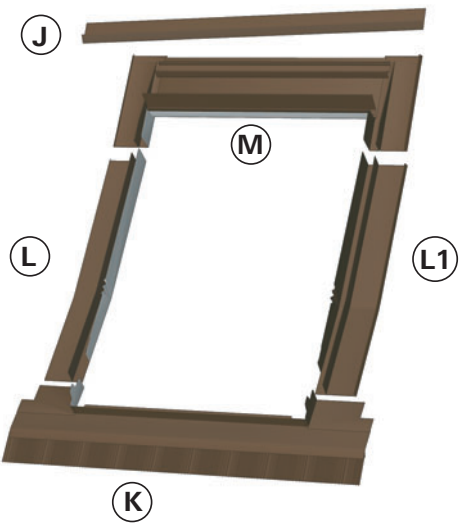

N	6
O	6

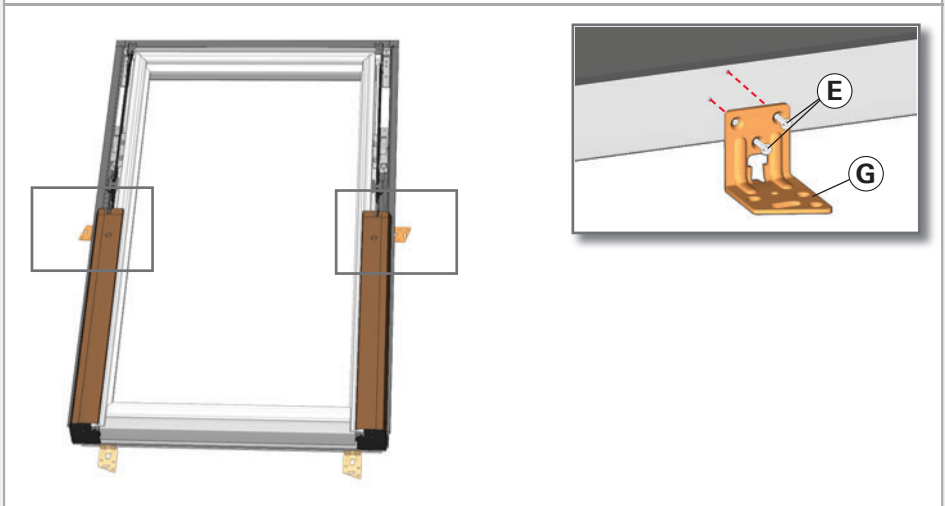
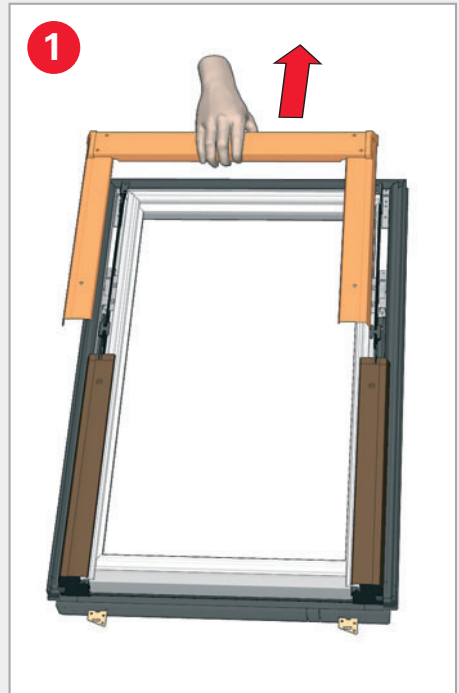
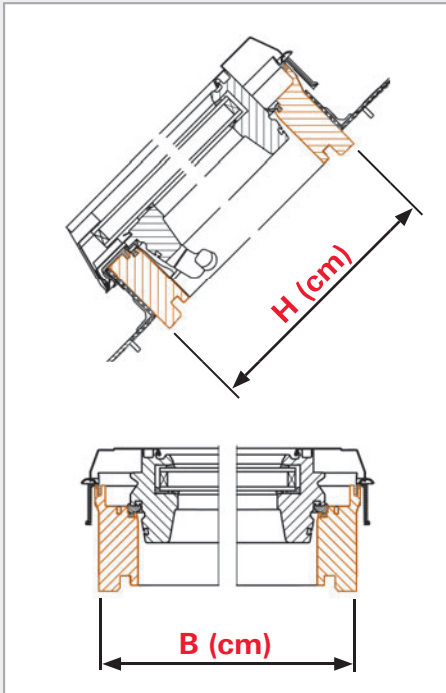



WDF
73. **K** ^{xx/16}



E 8x
ø3,9 x19



G 4x

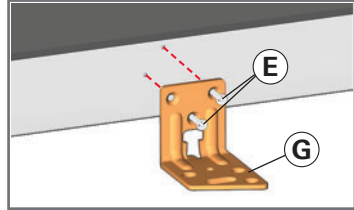
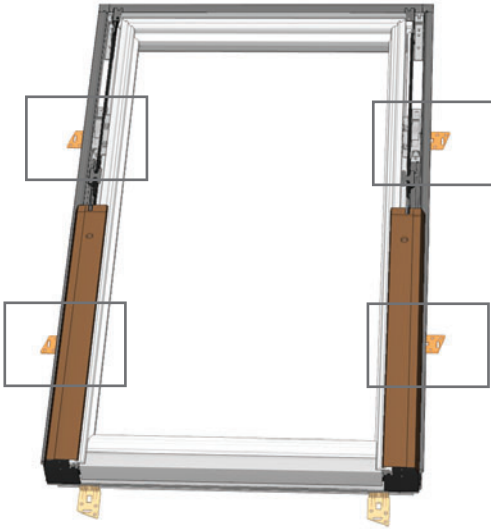

WDF
73. **H** ^{xx/16}



A 4x
ø3,5 x30



I 2x

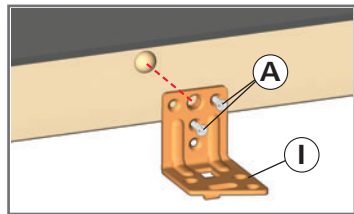
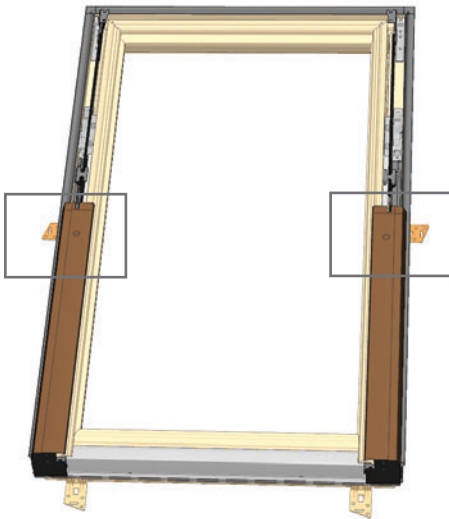

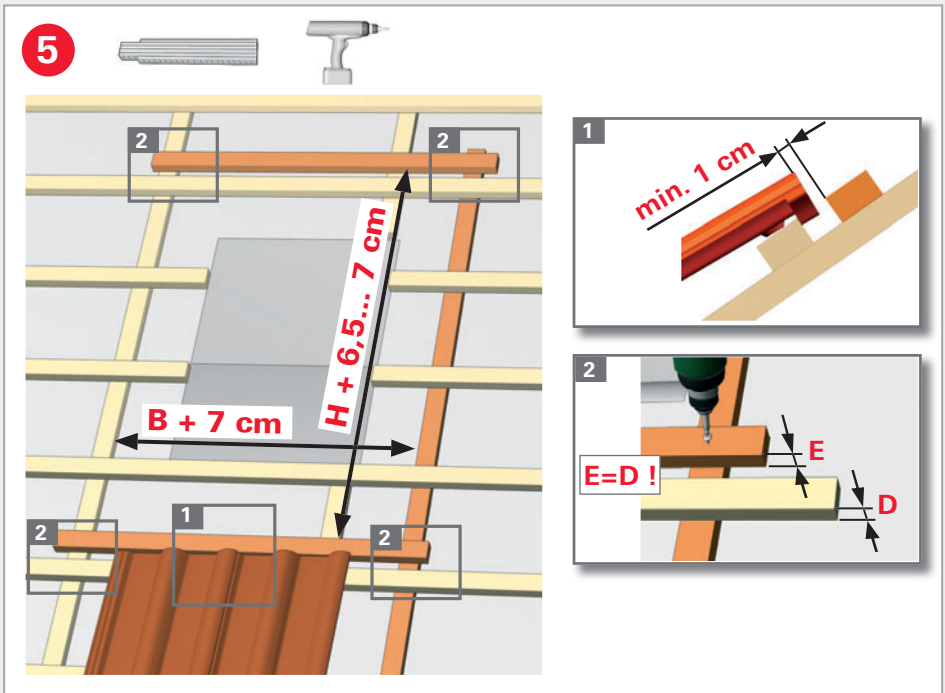
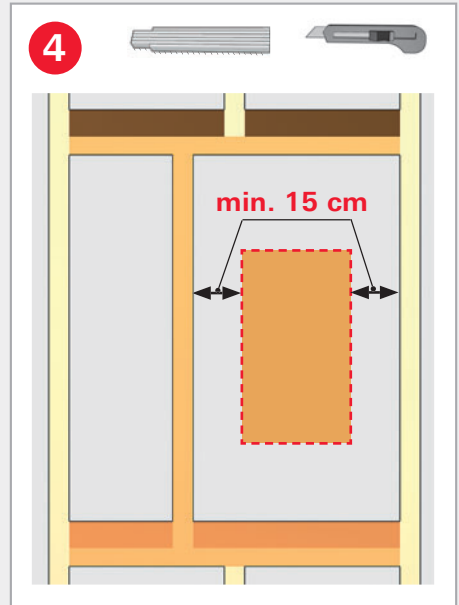
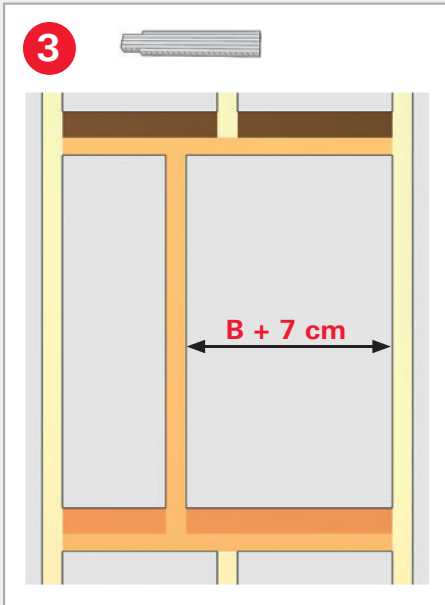

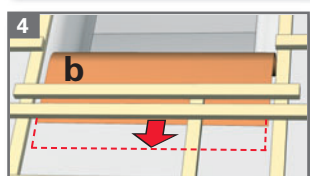
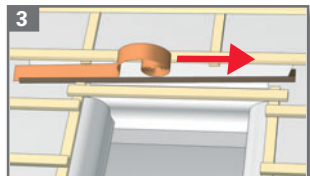
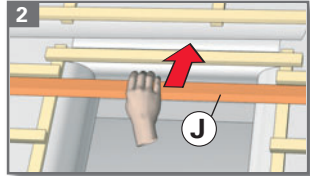
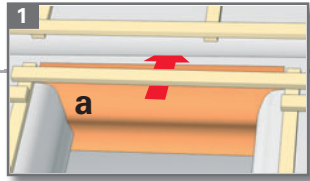
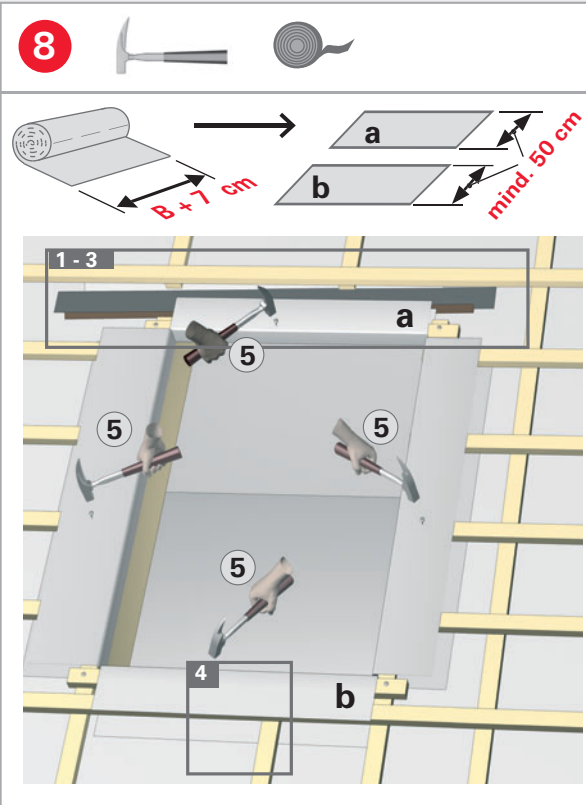
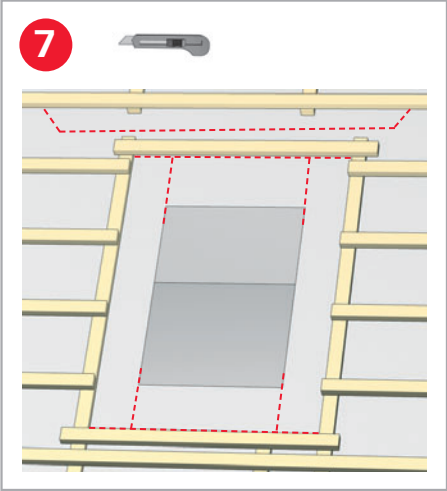
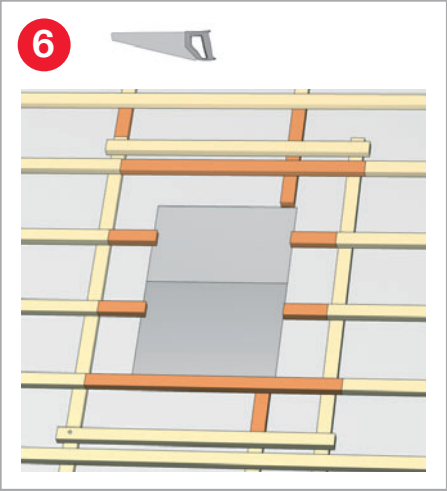

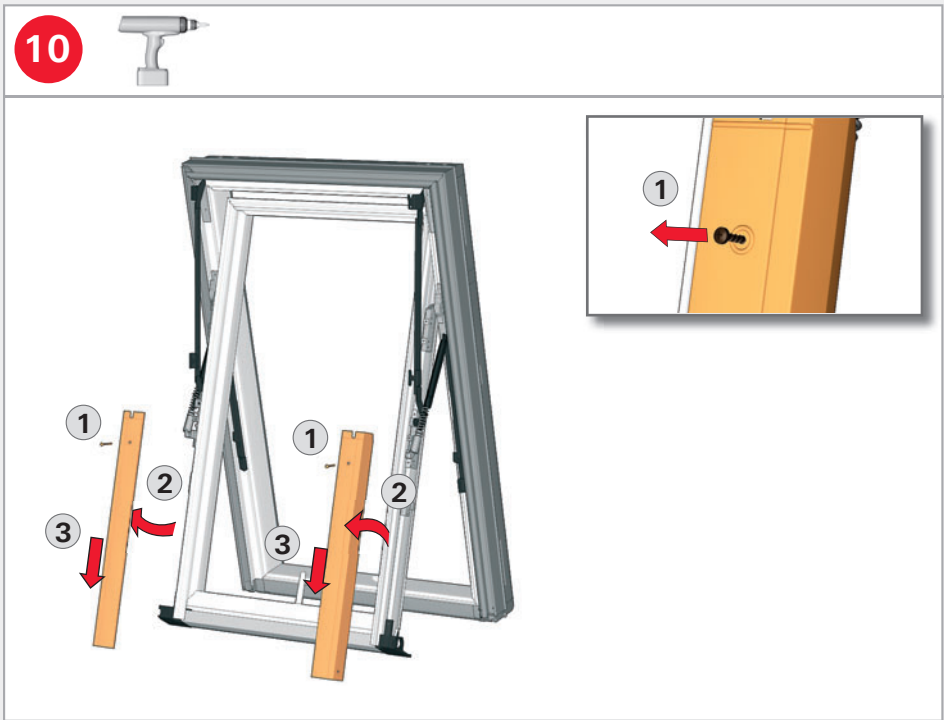
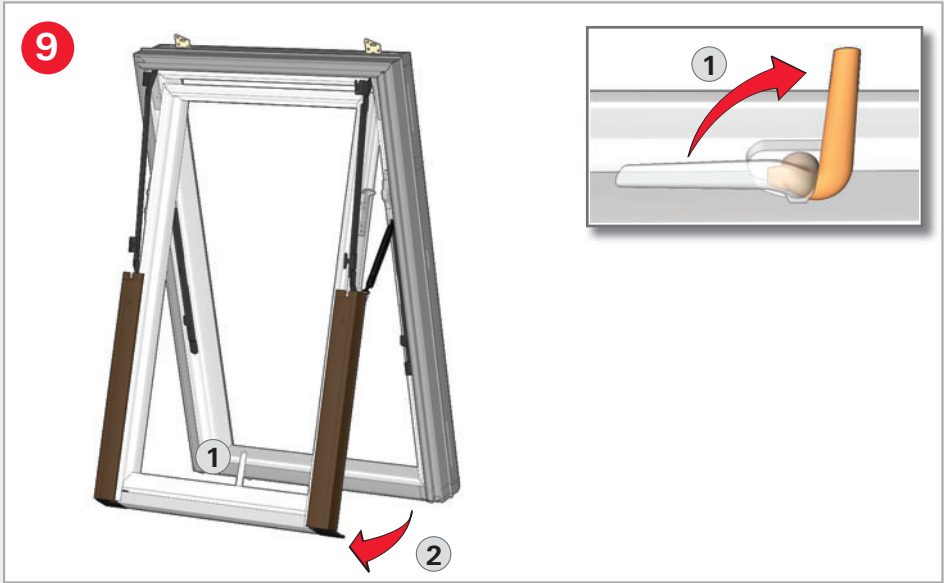

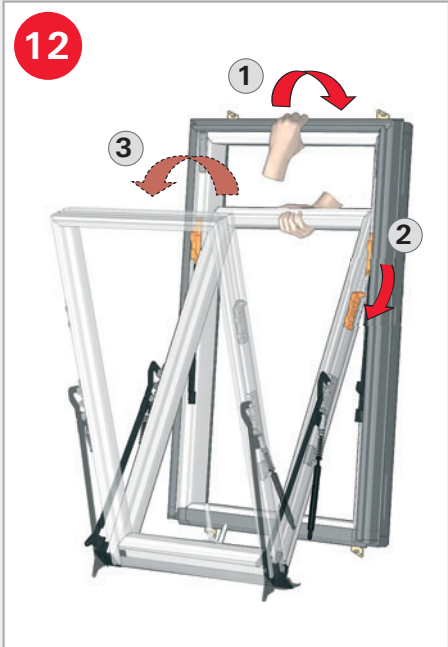
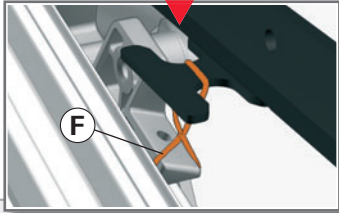
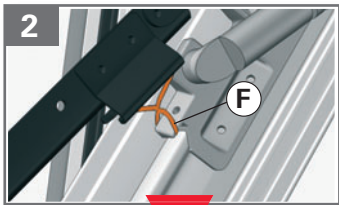
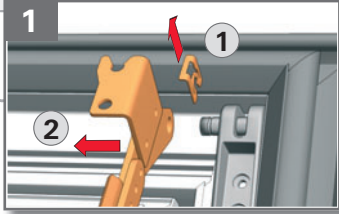
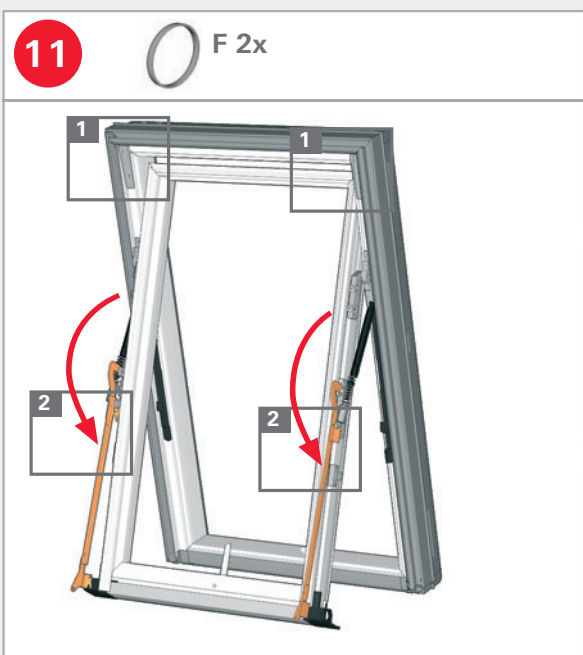

14



WDF 73. K 13/xx

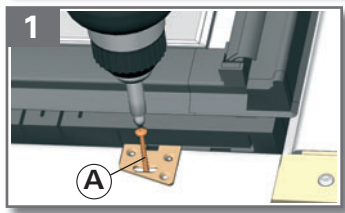
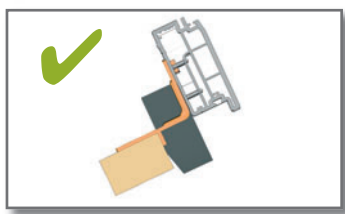
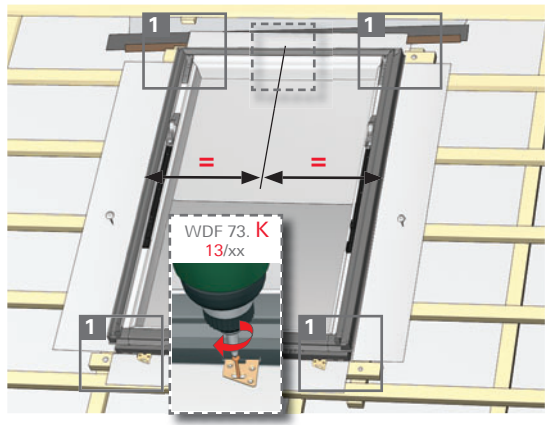

15

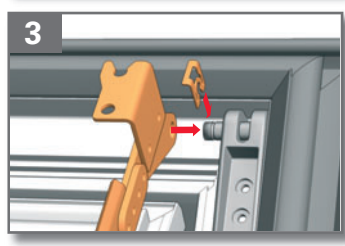
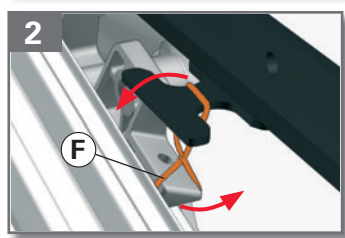
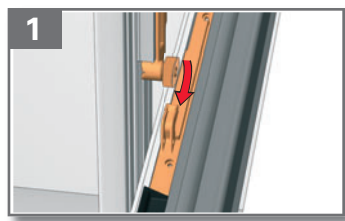
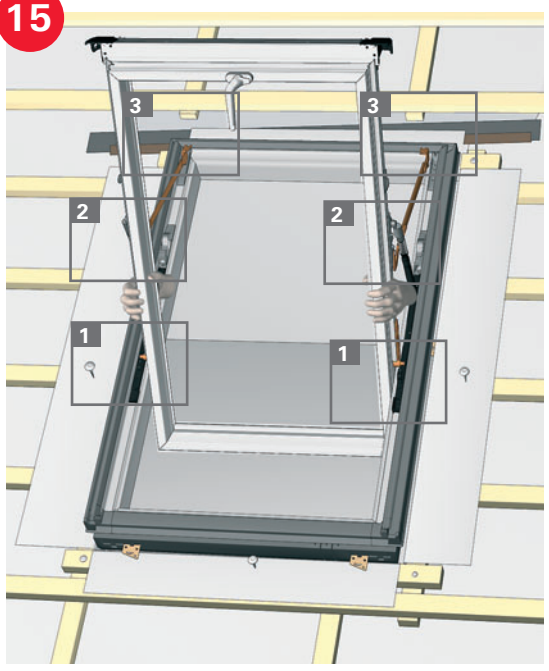

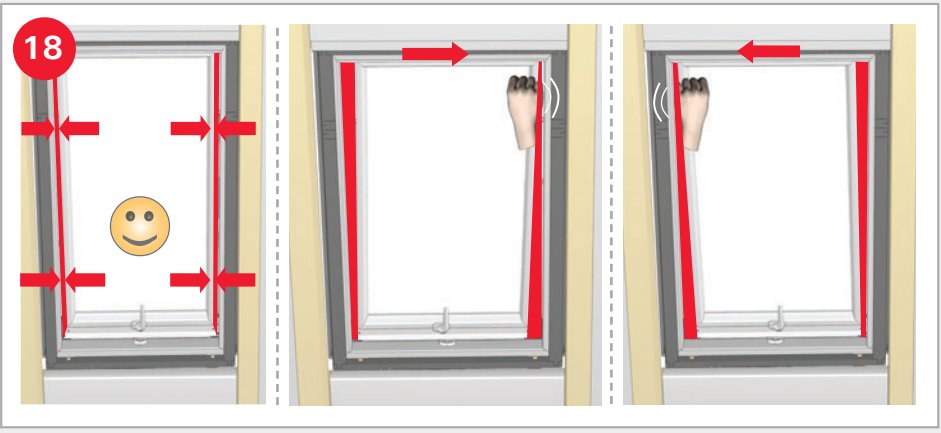
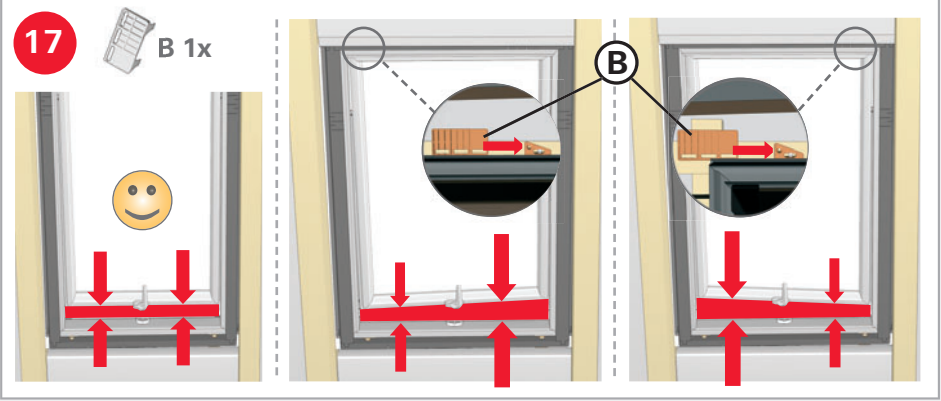
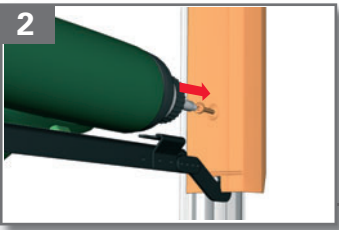
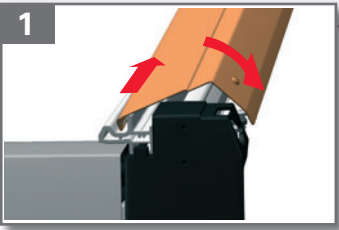
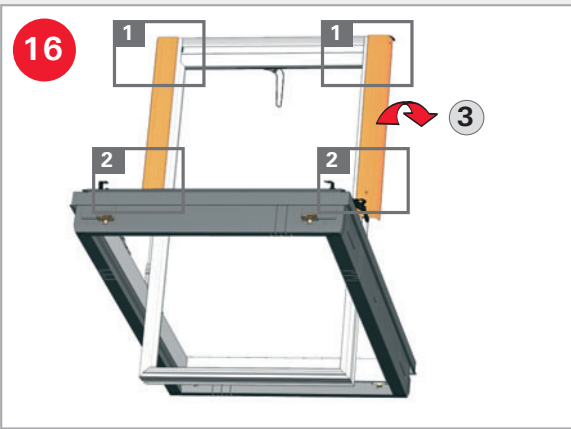

19



A 4x
ø3,5 x30

WDF
73. K 13/xx

A 6x
ø3,5 x30

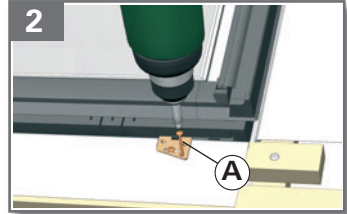
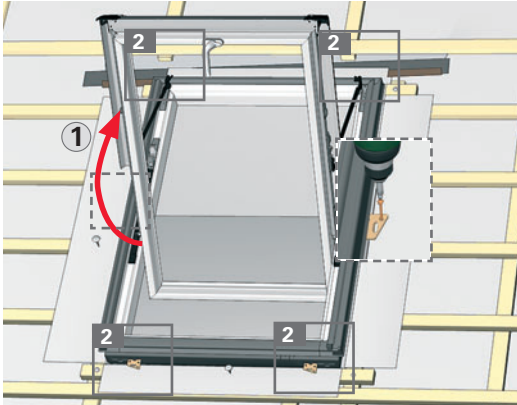

	xx/11, 14 xx/16			
	xx/16			
	B 2x B 4x			
	A 2x A 4x ø3,5 x30			

20

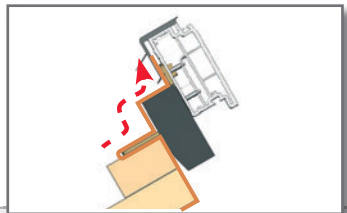
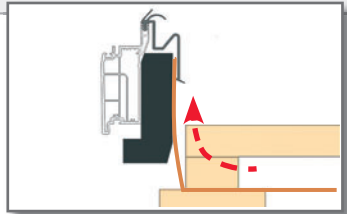
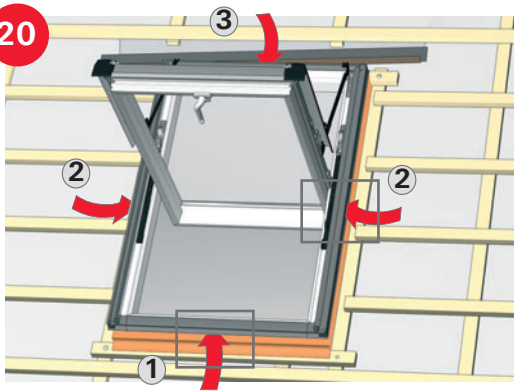



21

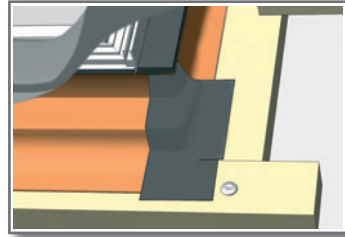
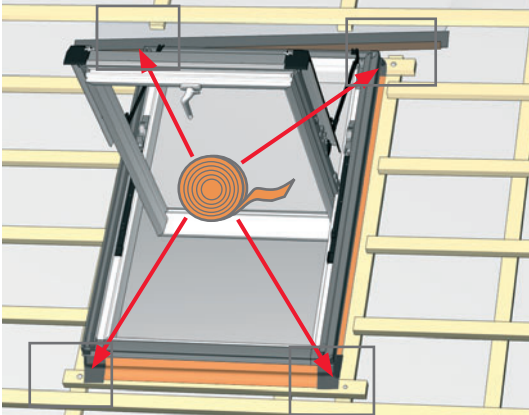

22



D 2x
ø3,5 x20



A 2x
ø3,5 x30



N 6x
O 6x

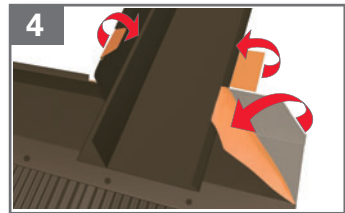
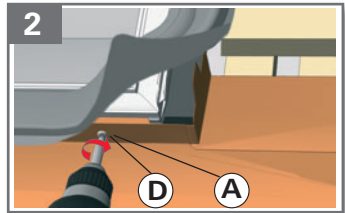
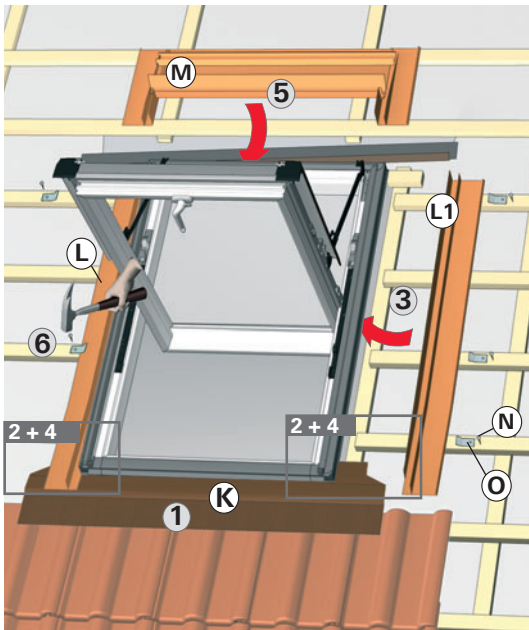

23

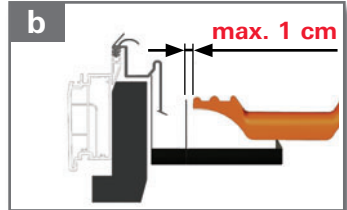
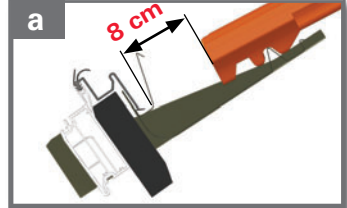
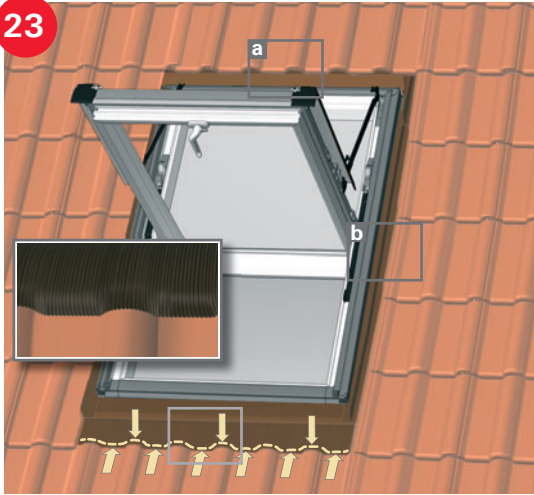



24

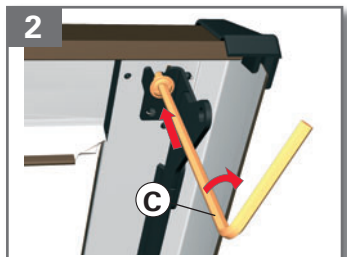
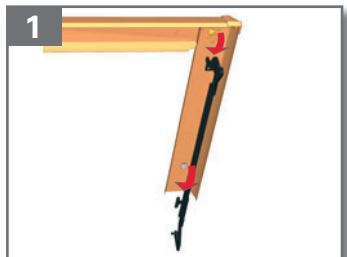
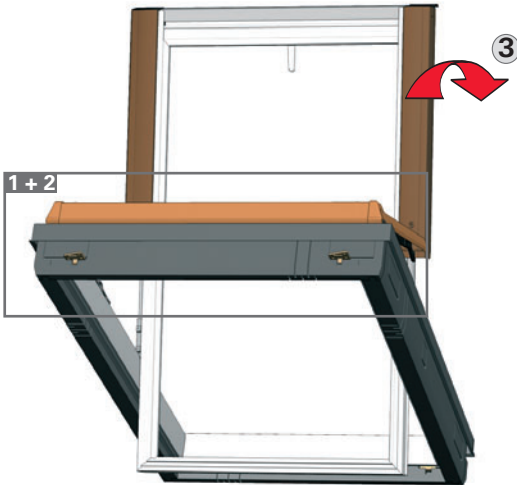

C 1x



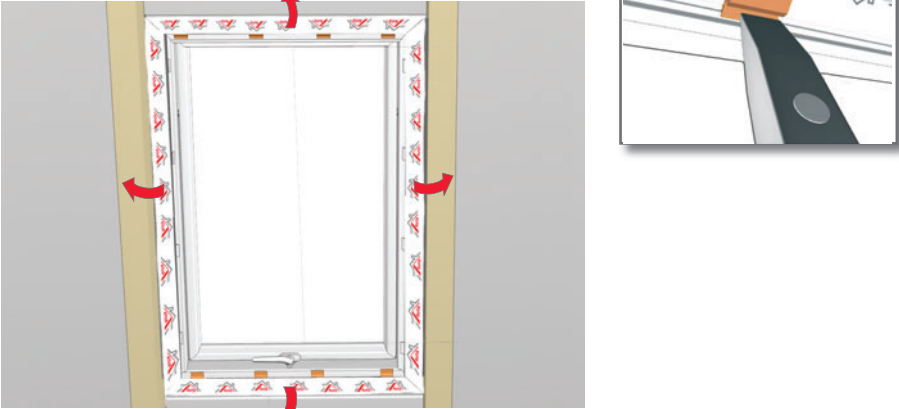

25   H 8x



26  

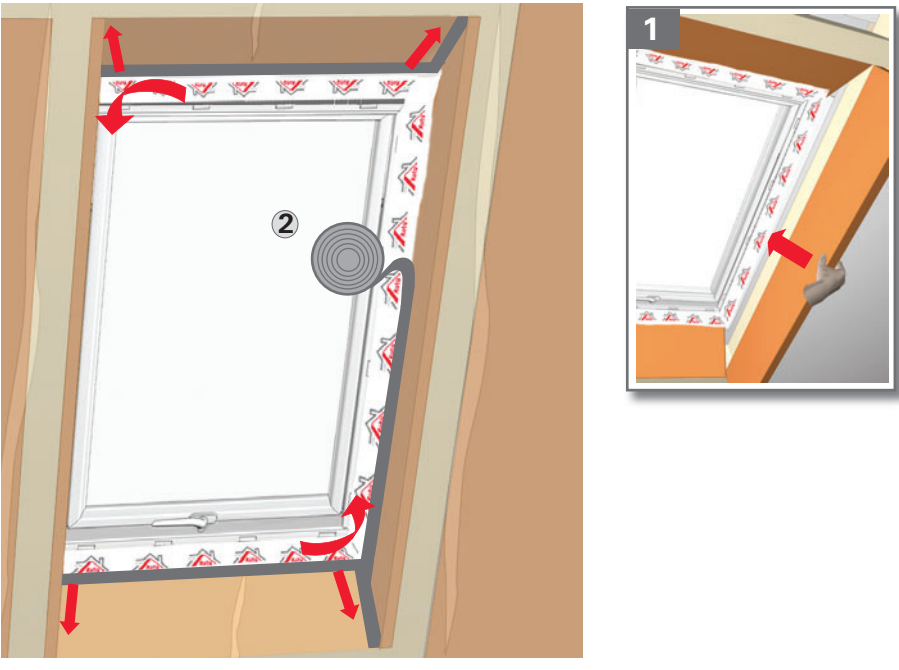

27

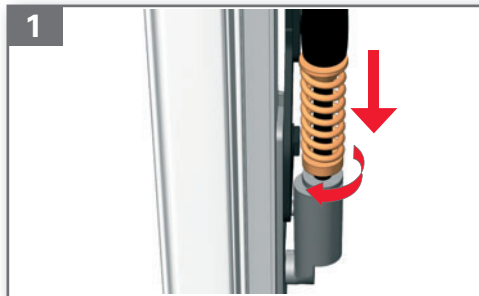
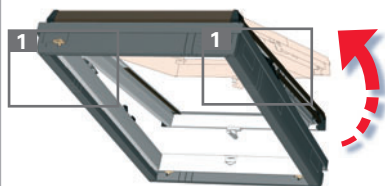

 Flügel springt immer auf? Feder auf beiden Seiten gleichmässig entspannen!	 Si l'ouvrant s'ouvre seul? Diminuer la tension des ressorts de la même valeur des deux côtés!
 If the sash is opening itself? You need to reduce the tension of the springs on both sides!	 Vleugel springt altijd open? Veren aan beide zijden gelijkmatig ontspannen!
 La hoja se abre siempre por si sola? Relajar el muelle uniformemente en ambos lados!	 Batente abrindo-se inadvertidamente? Distender a mola do mesmo modo em ambos os lados!
 Skrzydło zbyt intensywnie podnosi się? Równomierne po obu stronach pozłouwać sprężyny!	 Ваша створка открывается слишком резко? Нужно уменьшить натяжение пружин с обеих сторон.
 Kúľ aknapool ise avaneb? Tuleb mõlemalt poolt vedrusid lõõdvemaks lasta!	 Vērtne vienmēr atveras? Vienmērīgi atlaist atsperes abās pusēs!
 Varčia visada staiga pakyla? Spyruokles atpalaiduoti. Tolygiai iš abiejų lango pusių!	 Křídlo se samo otvírá? Povolit pružiny stejnoměrně na obou stranách!
 Krídlo sa samo otvára? Na obidvoch stranách rovnako povoliť pružiny!	 Az ablakszárny mindig kinyílik? A rugót mind két oldalon egyenletesen meg kell lazítani!
 Krilo se vedno odpre? Vymet na obeh straneh enakomerno popustite!	 Se il battente si apre di scatto? Allentare simmetricamente le molle su entrambi i lati!
 Prozorsko krilo se samo otvara? Ravnomojerno opustiti opruge s obje strane!	 Fereastra se deschide de la sine? Eliberați în aceeași măsură arcurile laterale!
 Το πτερύγιο ανοίγει πάντοτε ξαφνικά? Σφίξτε το ελατήριο και στις δύο πλευρές ομοιόμορφα!	

27A

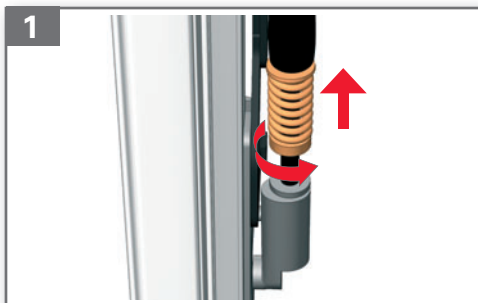
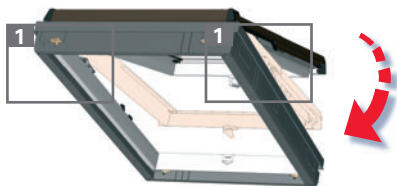

Flügel fällt immer zu?
Feder auf beiden Seiten gleichmäßig spannen!

Si l'ouvrant retombe?
Diminuer la tension des ressorts de la même valeur des deux côtés!

If the sash is closing itself?
You need to improve the tension of the springs on both sides!

Vleugel valt altijd open?
Veren aan beide zijden gelijkmatig ontspannen!

La hoja se cierra siempre por si sola?
Tensar el muelle uniformemente en ambos lados!

Batente fechando-se inadvertidamente?
Tender a mola do mesmo modo em ambos os lados!

Skrzydło ciągle opada?
Równomierzenie po obu stronach naciągając sprężyny!

Ваша створка не держится в открытом положении и/или самостоятельно захлопывается?
Нужно увеличить натяжение пружин с обеих сторон.

Kui aknapool ise sulgub?
Tuleb mõlemalt poolt vedrusid pingutada!

Vērtne vienmēr aizveras?
Vienmērīgi nospriegot atsperes abās pusēs!

Varčia pati užsidaro?
Spyruokles įtempti. Tolygiai iš abiejų labgą pusių!

Křídlo se samo zavírá?
Pružiny na obou stranách stejnoměrně napnout!

Křídlo sa samo zavára?
Na obidvoch stranách rovnako nastaviť pružiny!

Az ablakszárny mindig becsukódik?
A rugókat mindkét oldalon egyenletesen meg kell lazítani!

Krilo se vedno zapre?
Vymet na obeh straneh enakomerno napnite!

Se il battente si chiude di scatto?
Registrare simmetricamente le molle su entrambi i lati!

Prozorsko krilo se samo spušta?
Ravnomjerno zategnuti opruge s obje strane!

Fereastra se închide de la sine?
Înșurubați în aceeași măsură arcurile laterale!

Το πτερύγιο ανοίγει πάντοτε ξαφνικά?
Σφίξτε το ελατήριο και στις δύο πλευρές ομοιόμορφα!



📞 +49 (0)1805 905051*
☎ +49 (0)1805 904051
www.roto-frank.com



📞 +43 2757 21313-0
☎ +43 2757 21313-50
www.roto-frank.at
www.roto-frank.si



📞 +41 (0)44 267 47 47
☎ +41 (0)44 267 47 46
www.roto-frank.ch



📞 +33 (0)387 292430
☎ +33 (0)387 914901
www.roto-frank.fr



📞 +44 (0) 1788 558600
☎ +44 (0) 1788 558606
www.roto-frank.com



📞 +353 67 50700
☎ +353 67 34631
www.careyglass.com



📞 + 32 (0)89 778090
☎ + 32 (0)89 385788
www.roto.be



📞 + 32 (0)800 0232114
☎ + 32 (0)800 0232116
www.roto-frank.nl



📞 902 25 01 01
☎ 902 25 01 02
www.maydisa.com



📞 (236) 21 80 72
☎ (236) 21 73 26
☎ (236) 21 52 89
www.imporjan.com



📞 +48 81 855 05 22, 24, 25
☎ +48 81 855 05 28
www.roto.pl



Euroizol LTD
📞 +38 44 566 73 37
☎ +38 44 235 98 14
www.roto.ua



📞 +7 495 775 64 71, 81
☎ +7 495 775 64 79

Kaliningrad
📞 +7 401 277 96 44
www.roto.ru



BN-EESTI OÜ
📞 +372 7 346 171
☎ +372 7 346 172



SIA BN
📞 +371 732 77 00
☎ +371 732 77 01



UAB Morita
📞 +370 5 210 90 07
☎ +370 5 272 78 77
www.roto.lt



OOO Belpraktika
📞 +375 17 297 94 35
www.roto-frank.by



📞 +420 272 651428
☎ +420 271 750187
www.roto-frank.cz
www.roto.sk



📞 +36 99 534494
☎ +36 99 534498
www.roto.hu



📞 +39 0421 618738
☎ +39 0421 345125
www.orsogrillabbaini.com



📞 +385 (0)1/ 3490360
☎ +385 (0)1/ 3490362



📞 +40 312 281586 - 88
☎ +40 312 281589
www.roto-romania.ro



📞 +30 (2310) 796950
☎ +30 (2310) 796783
www.eurotechnica.gr



📞 +90 216 573 96 92
☎ +90 216 572 31 48

* 0,14 EUR / Min. aus dem dt. Festnetz. Mobilfunkpreise können abweichen.